

Directional Control Valves

- DG3V-3-*-60 Hydraulic Operated
- DG17V-3-*-60 Lever Operated
- DG18V-3-*-60 Air Operated
- DG20V-3-*-60 Cam Operated
- DG21V-3-*-60 Plunger Operated
- CETOP 3, NFPA D03, ISO 4401



Introduction

Vickers directional valves offer versatility of application for the many directional control requirements of hydraulic machinery. Ruggedness of design, manufacturing quality, and worldwide parts and service availability maximize uptime, resulting in greater profits for your company.

Manual Lever/Cam/Plunger Valves

These valves are available in an NFPA D03 interface. These valves are rated at flows to 75 l/min (20 USgpm) and 350 bar (5000 psi) maximum pressure. Roller cam, plunger, spring offset, detented, spring centered, knob or lever operated models are available.

Air Operated

Available in an NFPA D03 interface with rated flows to 75 l/min (20 USgpm) and maximum pressure of 350 bar (5000 psi).

Hydraulic Pilot Operated

Available in an NFPA D03 interface. Valves are rated at flows to 151 l/min (40 USgpm) and maximum pressure of 350 bar (5000 psi)

Feature and Benefits

- High pressure and flow capability for maximum cost-effectiveness
- Low headloss to minimize power loss
- Low-shock characteristics to maximize machine life
- Choice of five types of control to satisfy applications where electrical control is not appropriate
- Designed and manufactured by Vickers, with over 70 years as the global leader in fluid power and motion control.

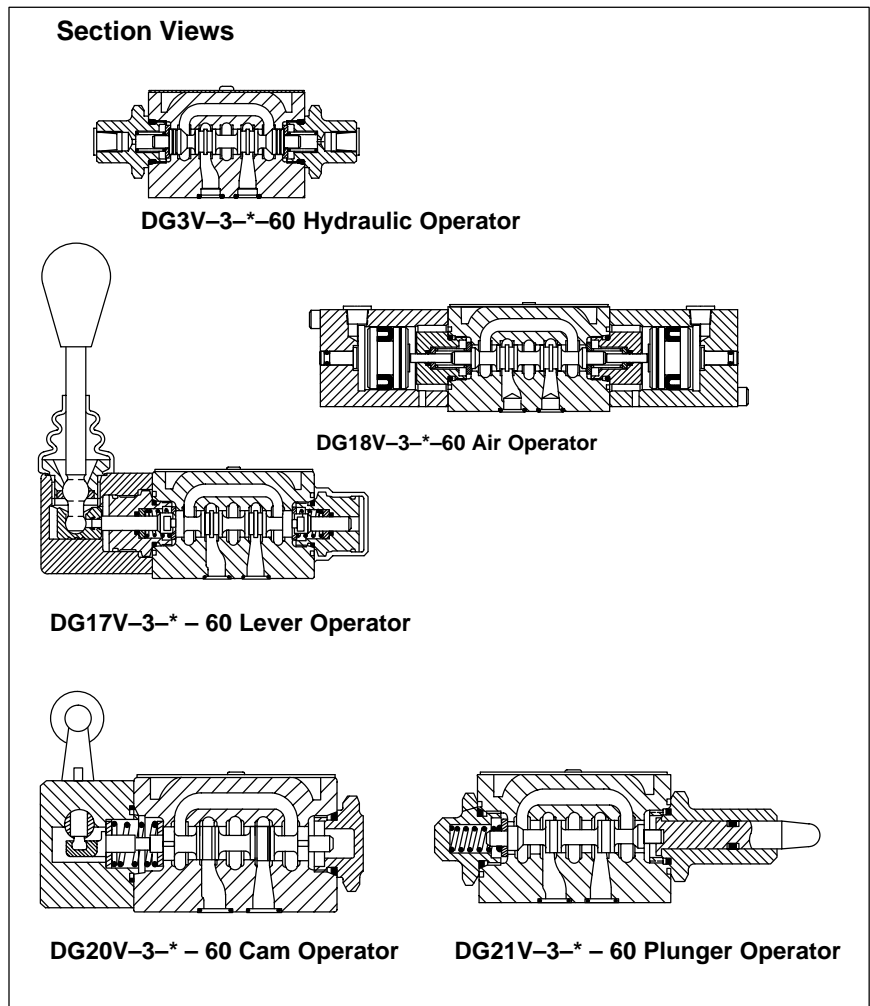

Table of Contents

General Information	4
DG3V-3-*-60 Hydraulic Operated	
DG**V-3-*-60 Lever/Cam/Plunger Operated	
DG18V-3-*-60 Air Operated	
Mounting Position	5
Service Literature	
Hydraulic Operator Model Code	7
DG3V-3-60 Functional Symbols	8
DG3V-3-60 Performance Data	9
DG3V-3-60 Installation Dimensions	10
Lever/Cam/Plunger Operator Model Code	11
DG17/20/21V-3-60 Functional Symbols	12
Pressure Drops	
DG17V-3-60 Installation Dimensions	15
DG20V-3-60 Installation Dimensions	16
DG21V-3-60 Installation Dimensions	17
Air Operator Model Code	18
DG18V-3-60 Functional Symbols	19
Pressure Drops	20
DG18V-3-60 Installation Dimensions	21
Mounting Interface	23
Application Data	24

General Information

General Description

Five types of valve are available with different controls primarily for controlling the starting, stopping and direction of fluid flow in a system.

Basically, the valves are developed from the well-known series of DG4V-3-60 series solenoid operated valves (see Vickers literature # GB-C-2015). These manual valves are available with a choice of up to nine different spool types, depending on valve configuration. All spools have been designed to provide good low-shock characteristics. External regulation of the control input by hydraulic, lever, pneumatic, cam or plunger operation allows matching to virtually any requirement where electrical control is not appropriate.

Models include no-spring, spring offset, spring centered and detented versions.

DG3V-3-*-60 Hydraulic Operated

The hydraulic operated DG3V-3-*-60 directional valves are used to control the direction of flow in a hydraulic circuit, which would control the movement of a work cylinder or the rotation of a fluid motor.

DG**V-3-*-60 Lever/Cam/Plunger Operated

Operating Information

The DG21V-3 plunger operator valves are internally drained to port T. They may be used only when surges or back pressure in the tank line cannot overcome the force applied to depress the plunger.

DG17/20/21 models must be released from actuated positions, without restriction to ensure proper spring return.

Manual lever and cam operations must be released from their actuated positions, without any restrictions to spring return.

Cam operated directional control valve installation recommendations:

- Maximum cam angle 35°
- Cam travel for dead band of 9° 30' on either side of center for closed center spools for 35° cam.
- This dead band should be taken into consideration when designing cam and system circuits.
- Cam should not drive roller at its vertical centerline to avoid any side loading on roller lever mechanism.

Actuation Force

Under rated conditions*, the approximate actuation force will be as shown in the chart below:

Valve type	Force Nm (lbf.)*
DG17V-3-*A	22 - 31 (5 to 7)
DG17V-3-*C	13 - 22 (3 to 5)
DG17V-3-*N	22 - 31 (5 to 7)
DG20V-3-*A	53 - 62 (12 to 14)
DG20V-3-*C	45 - 53 (10 to 12)
DG21V-3-*A	100 - 250 (22 to 56)

* Tank return must be designed so that transient tank line pressure peaks do not exceed 6,9 bar (100 psi). For tank return line pressure in excess of 6,9 bar (100 psi) lever movement must be assisted.

NOTE

In right hand assembly, operator "A" is always removed. In left hand assembly, operator "B" is always removed. **Please note that European designations are the opposite.** See diagram on the nameplate of the valve for operator (port) identification.

DG18V-3-**-60 Air Operated

Vickers air operated DG18V-3-**-60 directional control valves come in four basic versions: 3 position spring centered; 2 position detent; 2 position spring offset to port A, B operator; 2 position spring offset to port B, A operator.

NOTE

Manual actuator in end cap feature (P2) available on single operator models only. In right hand assembly, operator "A" is always removed. In left hand assembly, operator "B" is always removed. See identification plate on top of valve for operator (port) identification.

For every 3,3 bar (50 psi) increase in tank line pressure the air pilot pressure must be increased 0.07 bar (1 psi). Maximum tank line pressure is 100 bar (1450 psi).

Nameplate identification label is asymmetrical and fixes the "A" and "B" operators in relation to the "P" port. Designers should note for installation on vertical panels.

On all right hand models, when operator "A" is pressurized, flow is always P to A. When operator "B" is pressurized, flow is always P to B. Operators "A" and "B" are identified on the identification plate on top of the valve. For left hand assembly this is reversed (P to B when the "A" operator is pressurized).

Shift Time

Shift time is essentially dependent upon pilot pressure, line length and diameter, and speed of control mechanism. Spring return time from the offset to center position is approximately 45 msec. at rated flow and pressure assuming minimal back pressure in the pilot line.

General Information

Shifting Action

Spring centered and spring offset types will be spring positioned unless sufficient pilot pressure is maintained at pilot port to shift and hold the valve spool.

No-spring (offered as pilot valves for no-spring detented models only) require only momentary pressurization of pilot port to shift spool (approx. 0.1 seconds).

When pilot pressure is relieved, spool will remain in last position attained provided there is no severe shock, vibration or unusual pressure transients.

NOTE

Surges of oil in a common tank line serving these and other valves can be of sufficient magnitude to cause inadvertent shifting of these valves. This is particularly critical in the no-spring and no-spring detented type valves. Separate tank lines or a vented manifold with a continuous downward path to tank is preferred.

Any sliding spool, if held shifted under pressure for long periods of time, may stick and not spring return due to fluid residue formation (silting) and therefore, should be cycled periodically to prevent this from happening.

If this valve is used for purposes other than a 4-way valve or as shown in the graphical symbol on the valve, consult your distributor or sales engineer.

Mounting Position

There is no restriction on mounting of spring centered or spring offset models. Detented models must be mounted with the spool bore horizontal to reduce the possibility of accidental spool shift due to shock and/or vibration.

Port Connections

Port connections are made by mounting the valve on a manifold or subplate having mounting dimensions which conform to NFPA-D03 (ISO-4401-03) configurations.

Service Literature

The following literature items can be ordered through your local Vickers Distributor.

DG3V-3 Hyd. Operator	I-3895-S
DG17V-3 Lever Operator	I-3887-S
DG18V-3 Air Operator	I-3896-S
DG20V-3 Cam Operator	I-3893-S

DG3V-3*-60 Hydraulic Operator

Maximum flow:	See chart on page 9.
Maximum operating pressure:	350 bar (5000 psi)
Maximum tank line pressure:	210 bar (3000 psi)
Minimum pilot pressure:	See chart on page 9.
Recommended fluid viscosity range:	13-54 cSt
Weight:	1,2 kg (2.5 lbs.)

Operating Data

Control (swept) volume(s):	
DG3V-3**A(L) models, end-to-end:	0,8 cm ³ (0.050 in ³)
DG3V3-**B(L)/F(L) models:	
center-to-end	0,4 cm ³ (0.025 in ³)
DG3V-3-**C/N models:	
center-to-end	0,4 cm ³ (0.025 in ³)
end-to-end	0,8 cm ³ (0.050 in ³)

DG3V-3**(N) no-spring and detented valves require only momentary pilot pressurization to shift spool (in approx. 0.1 seconds). All other models require pilot pressure to be maintained to shift and hold the spool.

General Information

DG17/20/21-3-**-60 Lever/Cam/Plunger Operator

Maximum flow:	75 l/min (20 USgpm)
Maximum operating pressure:	(A, B & P ports) 350 bar (5000 psi)
Maximum tank line operating pressure:	6,9 bar (100 psi)
Maximum tank line pressure:	100 bar (1450 psi)
	10 bar (145 psi) DG21 model only
Recommended viscosity range	14 - 86 cSt (75 - 400 SUS) @ 18°C to 66°C (0°F to 150°F)

Weights:	
DG17V Lever operated	1,8 kg (4.0 lbs)
DG20V Cam operated	1,2 kg (2.5 lbs)
DG21V Plunger operated	1,2 kg (2.5 lbs)

DG18V-3-*-60 Air Operator

Maximum flow:	75 l/min (20 USgpm)
Maximum operating pressure:	(A, B & P ports) 350 bar (5000 psi)
Maximum tank line operating pressure*:	100 bar (1450 psi)
Maximum air pilot pressure:	10 bar (150 psi)
Minimum air pilot pressure:	1,7 bar (25 psi)
Operating temperature range:	-18° C to 66° C (0° F to 150° F)
Mounting interface:	ISO 4401-03, CETOP 3 (NFPA D03)
Recommended viscosity range:	14 - 86 cSt (75 - 400 SUS)
Weights:	
Dual operator models	1,5 kg (3.4 lbs.)
Single operator models	1,2 kg (2.7 lbs.)

* For every 3,3 bar (50 psi) increase in tank line pressure, the air pilot pressure must be increased 0,07 bar (1 psi).

Operating Data

Control (swept) volume(s):	
DG18V-3**A(L) end-to-end	3,6 cm ³ (0.219 in ³)
DG18V3-**B(L)/F(L) center-to-end	1,8 cm ³ (0.109 in ³)
DG3V-3-**C/N center-to-end	1,8 cm ³ (0.109 in ³)
end-to-end	3,6 cm ³ (0.219 in ³)

Hydraulic Operator Model Code

D G 3 V - 3 ** * (L) - (T) - (P1) - 7 - * - 60

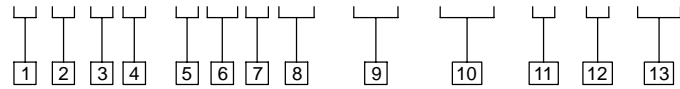

<p>1 Directional Control Valve</p> <hr/> <p>2 Subplate Mounted</p> <hr/> <p>3 Hydraulic Operated</p> <hr/> <p>4 Rated Pressure 350 bar (5000 psi) on P, A & B ports</p> <hr/> <p>5 Interface ISO 4401-03 (CETOP 3, NFPA D03) ISO 4401-AB-03-4-B</p> <hr/> <p>6 Spool Type 0 - Open center (all ports) 2 - Closed center (all ports) 3 - Closed center (P & B) 6 - Closed center (P only) 22 - Closed center - 2 way 33 - Closed center (block A & B)</p>	<p>7 Spool Spring Arrangement Blank – No spring A – Spring offset (single operator) B – Spring centered (single operator) C – Spring centered F – Spring offset, shift to center N – No-spring detented</p> <hr/> <p>8 Left-Hand Build (omit if not required) A, B & F models only</p> <hr/> <p>9 Internal Drain (omit if not required) A, B & F models only (F models must have internal drain) T - Internal drain</p>	<p>10 Manual Override (omit if not required) A, B & F models in non-operator end P1 - Manual override</p> <hr/> <p>11 Tank Pressure Limit 7 - 210 bar (3000 psi)</p> <hr/> <p>12 Thread for Pilot/Drain Connection B - G 1/8" threads S - SAE internal straight thread</p> <hr/> <p>13 Design Installation dimensions remain as shown for design numbers 60 thru 69.</p>
--	--	--

DG3V-3-60 Functional Symbols

Spool Options	Model	Basic Valve Symbol	Usable Spool Options
"0"	DG3V-3-**		0, 2, 6 & 22
"2"	DG3V-3-**A ♦		0, 2, 6 & 22
"3"	DG3V-3-**A-T ♦		0, 2, 6
"6"	DG3V-3-**B ♦		0, 2, 3, 6 & 33
"22"	DG3V-3-**B-T ♦		0, 2, 3, 6 & 33 └ R.H. build only
"33"	DG3V-3-**C		0, 2, 3, 6 & 33
	DG3V-3-**F-T ♦		0, 2, 3, 6 & 33 └ R.H. build only
	DG3V-3-**N		0, 2, 6

Single operator models marked ♦ are optionally available with a manual override in the non-operator end only. Models with operators at both ends are not available with manual overrides.

→ Full flow

→ Restricted flow

NOTE:

a) Pilot pressure must always exceed drain line pressure or, for internally drained valves, the T-line pressure by at least the requisite minimum pilot pressure. Open-center spools (0, 1 and 8) should be used only in externally drained valves.

b) Internally drained valves may be used only when surges in the tank line cannot possibly overcome the minimum pilot pressure differential referred to above. When the possibility of pressure surges in the tank line exist externally drained valves are recommended.

DG3V-3-*A(L) Performance Data

Pilot Pressure Requirements

The spools require the minimum pilot pressures shown in the graph below to overcome the spring force and any flow forces. Some spools are limited by the ability to spring return the valve.

Minimum pilot pressure required at a flow rate of 20 l/min (5.5 USgpm):

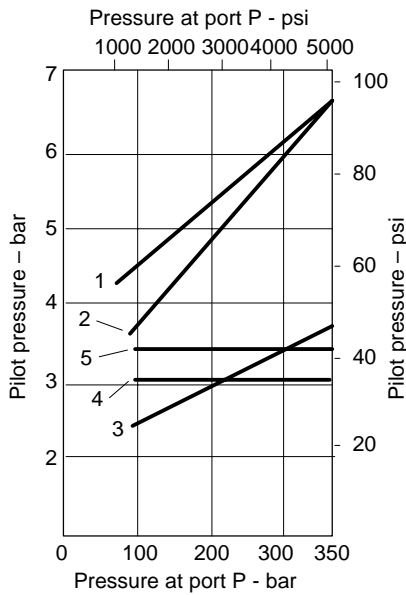

Spool/Spring	Curve
0A(L)	1
0C	3
0F(L)	3
2A(L)	1
2C	1
2F(L)	4
6A(L)	1
6C	1
6F(L)	4
22A	5
33C	2

Maximum Flow Rates

Some spools are limited in the conditions they will operate without reliability problems. These are the single ended spools which must operate within limits outlined in the graph below.

Spool malfunction limits

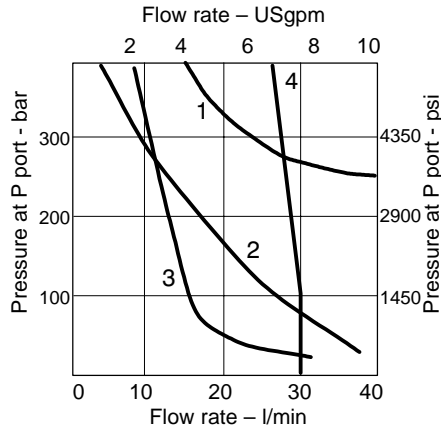

Pressure Drop Curves

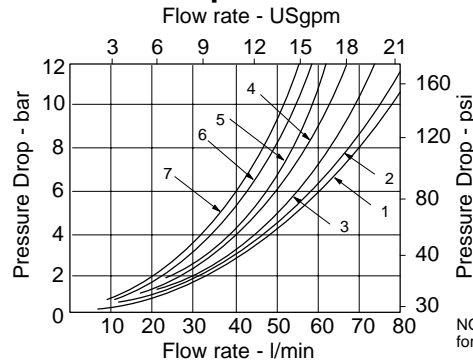

Pressure Drop Characteristics

The pressure drop curves give approximate pressure drop ΔP when passing 21 cSt (100 SUS) fluid(s) having .87 specific gravity.

For any other viscosity the pressure drop ΔP will change as follows:

Viscosity	14	32	43	54	65	76	86
cSt							
(SUS)	(75)	(150)	(200)	(250)	(300)	(350)	(400)
% of ΔP (Approx.)	93	111	119	126	132	137	141

For any other specific gravity (G_1)^{*} the pressure drop ΔP will be approximately:

$$\Delta P_1 = \Delta P (G_1 / G)$$

* Specific gravity of fluid may be obtained from its producer. Fire-resistant fluids have higher specific gravities than oil.

Spool/Spring	Curve
0A(L)	1
2A(L)	2
6A(L)	3
22A(L)	4

NOTE: For spool types 3 and 6; not recommended for flows in excess of 60 l/min (15.8 USgpm).

Spool/Spring	P to A	A to T	P to B	A to T	P to T	Max flow l/min (USgpm) @ 350 bar (5000 psi)
0	4	2	4	2	4 ▼	38 (10)
0A	5	2	5	2	4 ▼	■
0B, 0C, 0F	4	2	4	2	4	38 (10)
0N	3	7	3	7	4 ▼	38 (10)
2	5	2	5	2	—	38 (10)
2A	6	5	6	5	—	■
2B, 2C, 2F	5	2	5	2	—	38 (10)
2N	6	3	6	3	—	38 (10)
3B, 3C, 3F	6	3	6	1	—	38 (10)
6	6	1	6	1	—	38 (10)
6A	5	7	5	7	—	■
6B, 6C, 6F	6	1	6	1	—	38 (10)
6N	7	1	7	1	—	38 (10)
22A	6	—	6	—	—	■
33B, 33C, 33F	5	2	5	2	▲	38 (10)

▲ Type "33" spool at center will pass approx. 20 l/min (5.3 USgpm) at 124 bar (1800 psi) pressure drop from port A or B (the other being plugged) to T.

▼ Transient condition.
■ See graph above, Max. Flow Rates.

DG3V3 Installation Dimensions

DG3V3-3-*60 Hydraulic Operated

Millimeters (inches)

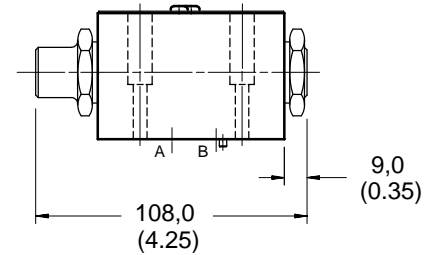
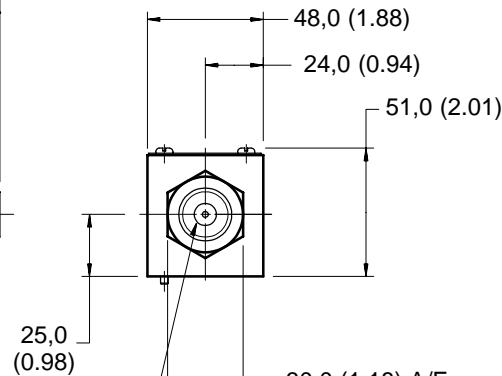
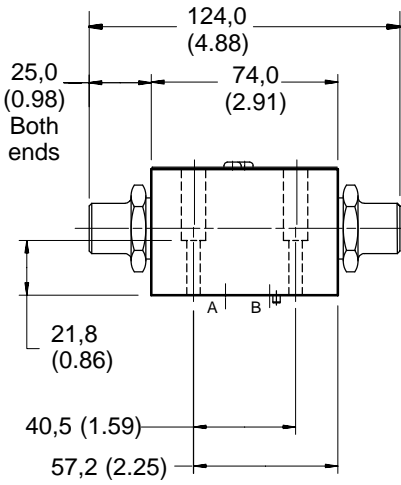

DG3V3-3-**A-T-7-*60
 DG3V3-3-**B-T-7-*60
 DG3V3-3-**F-T-7-*60

Pilot/drain connection
 B - G¹/₈ thread
 S - SAE straight thread
 (7/16" - 20 UNF)

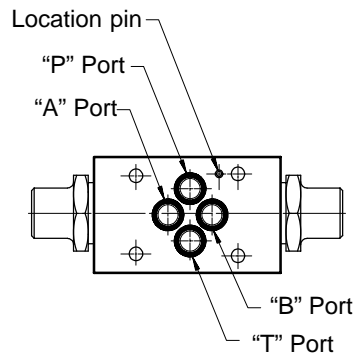

DG3V3-3-**(L)-7-*60
 DG3V3-3-**A(L)-7-*60
 DG3V3-3-**B(L)-7-*60
 DG3V3-3-**C-7-*60
 DG3V3-3-**N-7-*60

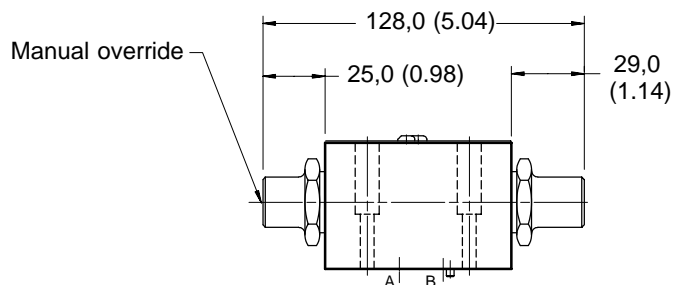

DG3V3-3-**A-T-P1-7-*60
 DG3V3-3-**B-T-P1-7-*60
 DG3V3-3-**F-T-P1-7-*60

Lever/Cam/Plunger Operator Model Code

D G ** V - 3 - * * (L) - 60

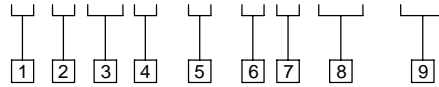

1 Directional Control Valve

2 Subplate Mounted

3 Operator

17 - Lever operated
 20 - Roller cam operated
 21 - Plunger operated

4 Rated Pressure

350 bar (5000 psi)

5 Interface

ISO 4401-03 (CETOP 3, NFPA D03)

6 Spool Type (center condition)

0 - Open center (all ports)
 2 - Closed center (all ports)
 6 - Closed center (P only)
 7 - Open center (P to A & B, T blocked)
 (DG17 models only)
 8 - Tandem center (P to T)
 22 - Closed center (two-way)
 (DG17 models only)
 33 - Closed center (bleed A & B)

7 Spool Spring Arrangement

A - Spring offset to center position No.2
 (see installation dimensions)
 A2 - Spring offset from position No.2 to
 position No.1 (DG20V cam operator
 only)
 C - Spring centered
 N - No-spring detented
 (DG17V lever operator only)







8 Left-hand Assembly

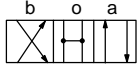
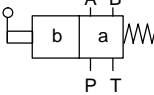
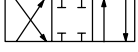
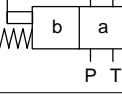

(omit for standard right-hand
 assembly shown)

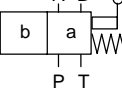
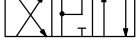
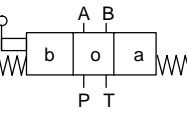
9 Design

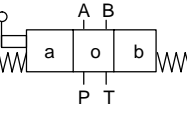
Installation dimensions remain as shown
 for design numbers 60 thru 69

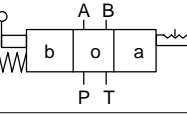
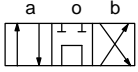
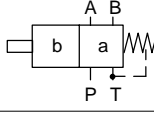
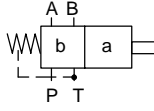
DG17/20/21V-3-*-60 Functional Symbols

Spool Options	Model	Basic Valve Symbol	Usable Spool Options
"0" 	DG17V-3-**A DG20V-3-**A		0, 2, 6, & 22 0, 2, 6, & 22
"2" 	DG20V-3-**A2		0, 2, 6 & 33
"6" 	DG20V-3-**A2L		0, 2, 6 & 33
"7" 	DG17V-3-**C DG20V-3-**C		0, 2, 6, 7 & 33 0, 2, 6, & 33
"22" 	DG17V-3-**8C		8
"33" 	DG17V-3-**N		0, 2, 6, 7 & 33
"8" 	DG21V-3-2A		2
	DG21V-3-2AL		2

 Full flow
 Restricted flow

DG17V-3 Pressure Drops

DG17V-3-**-60

Pressure drop curve reference chart

Maximum flow
@ 350 bar
(5000 psi)

Spool type		P → A	B → T	P → B	A → T	P → T @ CENTER	Maximum flow @ 350 bar (5000 psi)	
	"0C"	4	2	4	2	4		75 l/min (20 USgpm)
	"2C"	5	2	5	2	—		
	"6C"	6	1	6	1	—		
	"7C"	4	3	4	3	—		
	"33C"	5	2	5	2	**		
	R.H. "0A"	5	2	5	2	—		
	R.H. "2A"	6	5	6	5	—		
	L.H. "6A"	5	7	5	7	—		
	"22A"	6	—	6	—	—	55 l/min (15 USgpm)	
	"0N"	4	2	4	2	4	75 l/min (20 USgpm)	
	"2N"	5	2	5	2	—		
	"6N"	6	1	6	1	—	55 l/min (15 USgpm)	
	"7N"	4	3	4	3	—	38 l/min (10 USgpm)	
	"33N"	5	2	5	2	**		

**Note type "33" spool at center will pass approximately 20 l/min. (5.3 USgpm) at 124 bar (1798 psi) inlet pressure.

The pressure drop curves give approximate pressure drop ΔP when passing 36 cSt (100 SUS) fluid(s) having .87 specific gravity.

For any other viscosity the pressure drop ΔP will change as follows:

Viscosity							
cSt	14	32	43	54	65	76	86
(SUS)	(75)	(150)	(200)	(250)	(300)	(350)	(400)
% of ΔP	93	111	119	126	132	137	141
(Approx.)							

For any other specific gravity (G_1)^{*} the pressure drop ΔP will be approximately: $\Delta P_1 = \Delta P (G_1 / G)$

* Specific gravity of fluid may be obtained from its producer.

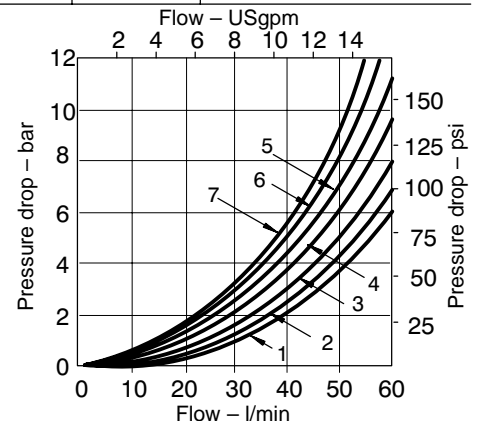

DG20/21V-3 Pressure Drops

DG20/21V-3-**-60

Pressure drop curve – reference chart

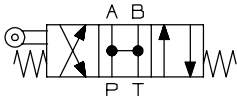
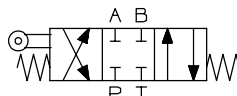
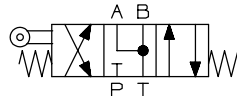
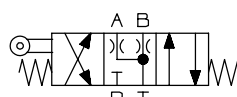
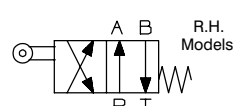
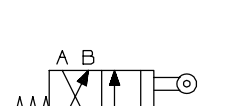
Spool type	P → A	B → T	P → B	A → T	P → T @ CENTER	Maximum flow @ 350 bar (5000 psi)
 "0C"	2	2	2	2	2	
 "2C"	2	3	2	3	—	
 "6C"	3	1	3	1	—	
 "33C"	2	2	2	2	**	38 l/min (10 USgpm)
 "0A" R.H. Models	2	2	2	2	—	
	"2A"	2	3	2	3	
 "33A" L.H. Models	2	2	2	2	—	
	"6A"	3	1	3	1	—

**Note type "33" spool at center will pass approximately 20 l/min. (5.3 USgpm) at 124 bar (1798 psi) inlet pressure.

The pressure drop curves give approximate pressure drop ΔP when passing 36 cSt (100 SUS) fluid(s) having .87 specific gravity.

For any other viscosity the pressure drop ΔP will change as follows:

Viscosity								
cSt	14	32	43	54	65	76	86	
(SUS)	(75)	(150)	(200)	(250)	(300)	(350)	(400)	
% of ΔP (Approx.)	93	111	119	126	132	137	141	

For any other specific gravity (G_1)* the pressure drop ΔP will be approximately:

$$\Delta P_1 = \Delta P (G_1 / G)$$

* Specific gravity of fluid may be obtained from its producer.

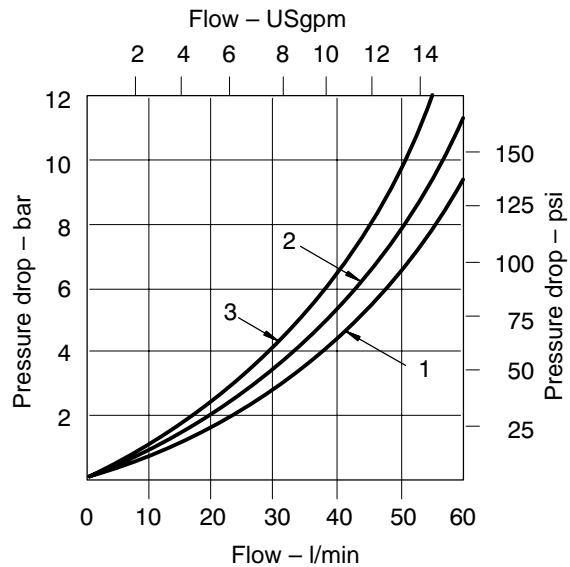

DG20V-3 Installation Dimensions

DG20V-3-***-60** Cam Operated

Millimeters (inches)

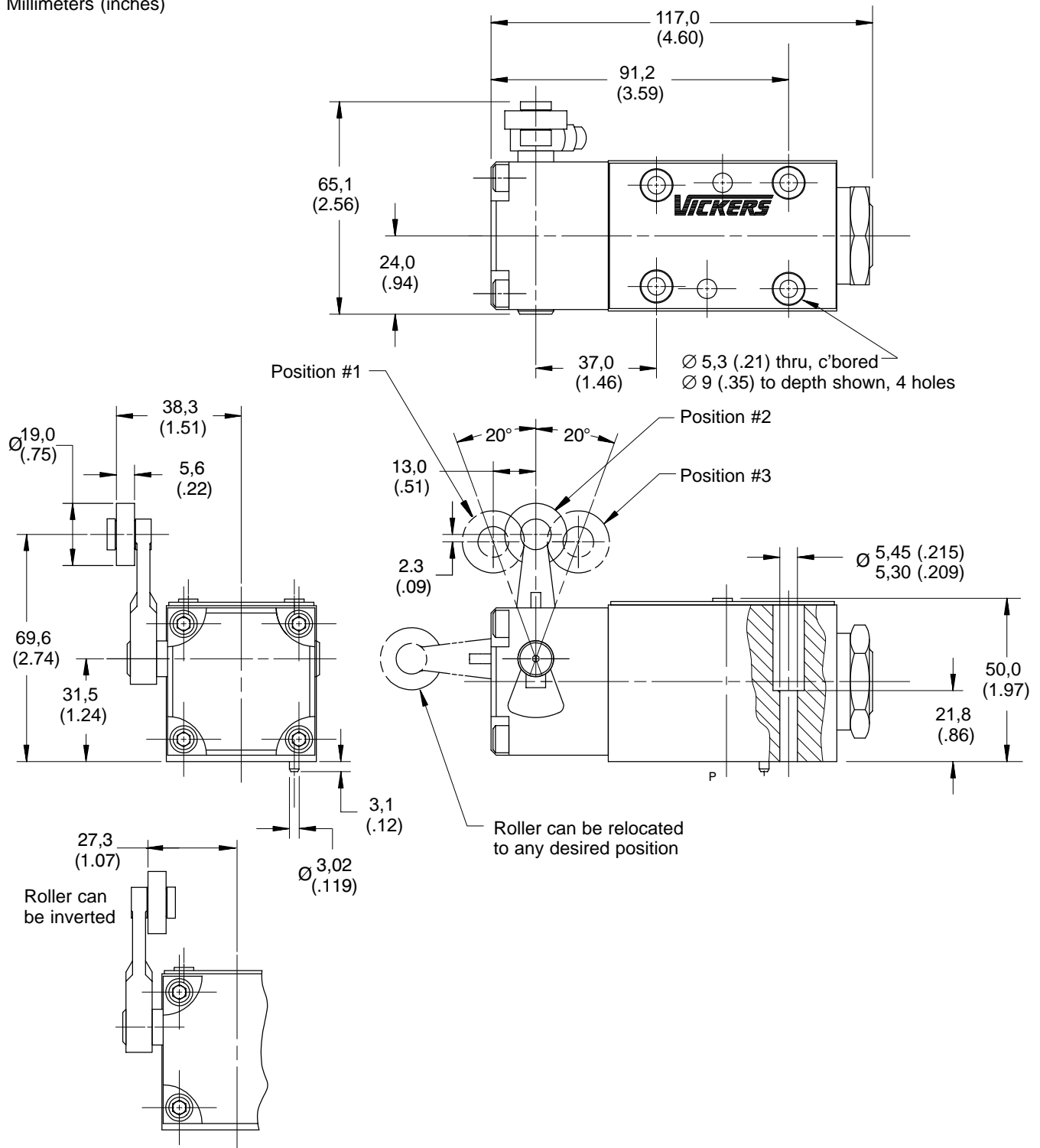

DG21V-3 Installation Dimensions

DG21V-3-A(L)-2-60 Plunger Operated

Millimeters (inches)

Operating force, is dependent on hydraulic conditions and from 100-250 Nm (22-56 lb ft), must be applied axially.

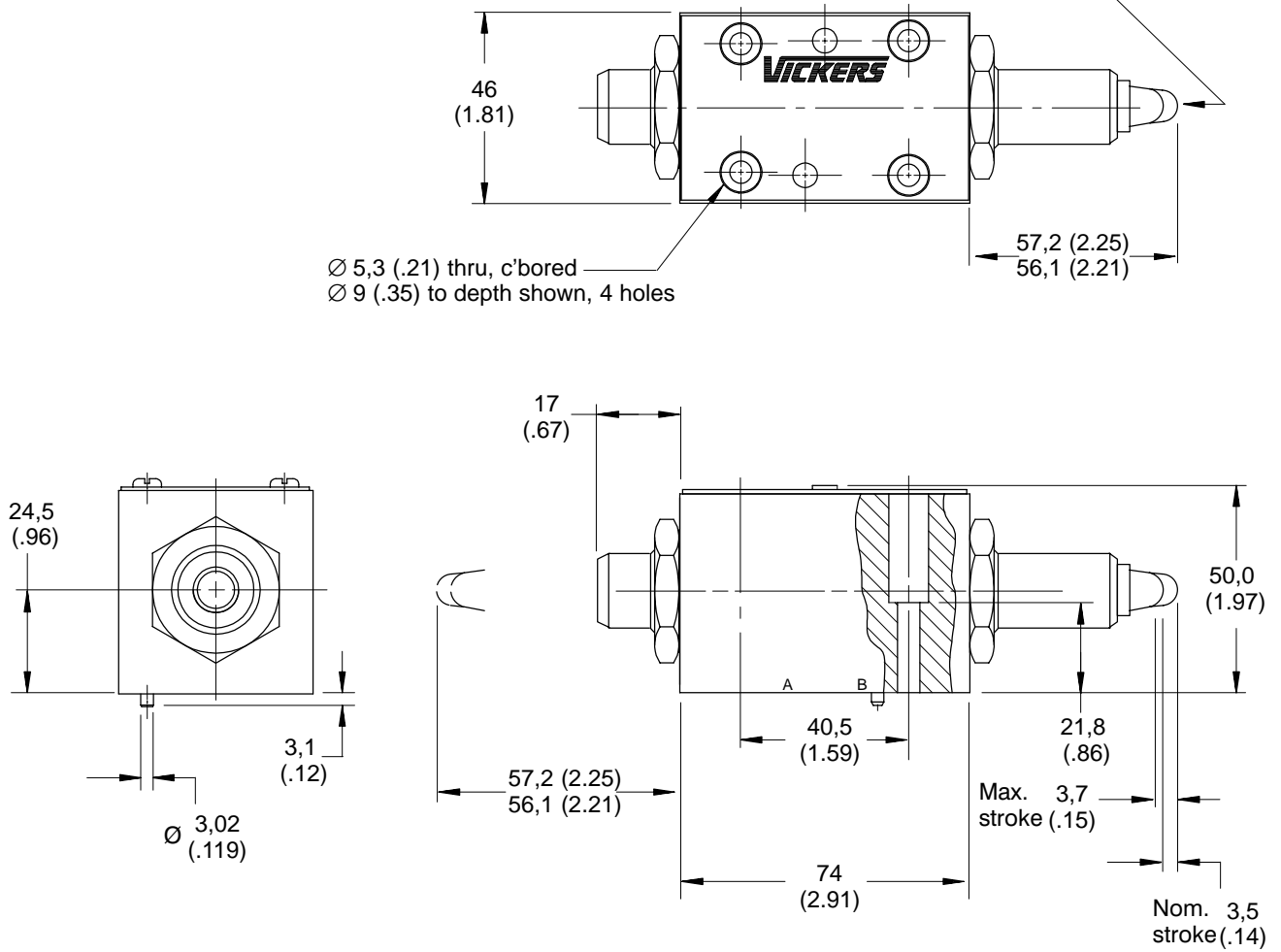

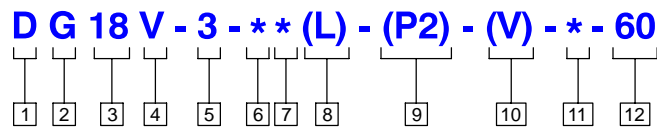

Air Operator Model Code

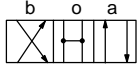
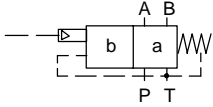
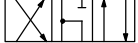
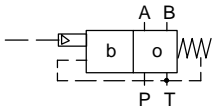
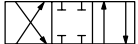
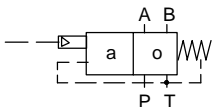
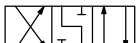
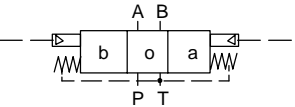
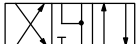
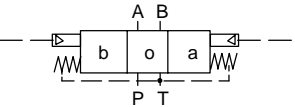

<p>1 Directional Control Valve</p> <hr/> <p>2 Manifold or Subplate Mounted</p> <hr/> <p>3 Air Operator</p> <hr/> <p>4 Rated Pressure 350 bar (5000 psi)</p> <hr/> <p>5 Interface ISO 4401-03 (CETOP 3, NFPA D03)</p> <hr/> <p>6 Spool Type (center condition)</p> <p>0 - Open center (all ports) 1 - Open center (P & A to T) 2 - Closed center (all ports) 3 - Closed center (P & B) 6 - Closed center (P only) 7 - Open center (P to A & B, T blocked) 8 - Tandem center (P to T) 11 - Open center (P & B to T) 22 - Closed center (two-way) 31 - Closed center (P to A) 33 - Closed center (bleed A & B)</p>	<p>7 Spool Spring Arrangement</p> <p>A - Spring offset to A, (single operator) AL - Spring offset to B, L.H. build (single operator) B - Spring centered, operator A removed (single operator) BL - Spring centered, operator B removed (single operator) C - Spring centered (dual operator) F - Spring offset, shift to center (single operator) FL - Spring offset, shift to center, L.H. build (single operator) N - No-spring detented</p> <hr/> <p>8 Manual Override Option</p> <p>(Applicable for A(L), B(L) & F(L) models only) Blank - Overrides in operator end only P2 - Override in both ends of single operators</p>	<p>9 Actuator Identity</p> <p>Blank - Standard arrangement (i.e. apply air to operator A to give flow P to A) (Ref. US ANSI B93.9)</p> <p>V - Operator identification determined by position of operator (i.e. operator A at A port end of valve operator B at B port end of valve)</p> <p>NOTE: Type 8 spool conforms to both methods. All type 8 spools must designate V in model code.</p> <hr/> <p>10 Pilot Source Thread Connections</p> <p>P - 1/8" NPT threads B - 1/8" BSP threads</p> <hr/> <p>11 Design</p> <p>Installation dimensions remain as shown for design numbers 60 thru 69.</p>
---	--	---

DG18V-3-*--60 Functional Symbols

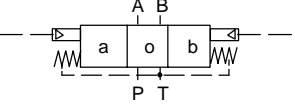
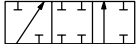
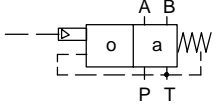
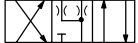
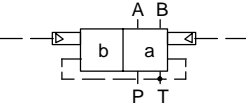
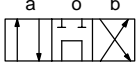
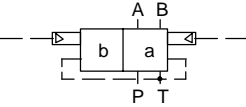
Spool Options	Model	Basic Valve Symbol	Usable Spool Options
"0" 	DG18V-3-**-A ♦		0, 2, 6, 7 & 22
"1" 	DG18V-3-**-B ♦		0, 1, 2, 3, 6, 7 & 33
"2" 	DG18V-3-**-8B ♦		8
"3" 	DG18V-3-**-C		0, 1, 2, 3, 6 & 33
"6" 	DG18V-3-**-C		0, 1, 2, 3, 6 & 33
"7" 	DG18V-3-**-8C		8
"22" 	DG18V-3-**-F ♦		0, 1, 2, 3, 6, 7 & 33
"33" 	DG18V-3-**-N		0, 2, 6
"8" 	DG18V-3-**-N		0, 2, 6

Single operator models marked ♦ are optionally available with a manual override in the non-operator end only. Models with operators at both ends are not available with manual overrides.

→ Full flow

→ Restricted flow

NOTE:

a) Pilot pressure must always exceed drain line pressure or, for internally drained valves, the T-line pressure by at least the requisite minimum pilot pressure. Open-center spools (0, 1 and 8) should be used only in externally drained valves.

b) Internally drained valves may be used only when surges in the tank line cannot possibly overcome the minimum pilot pressure differential referred to above. When the possibility of pressure surges in the tank line exist externally drained valves are recommended.

DG18V-3 Pressure Drops

DG18V-3-**-60

Maximum flow without malfunction @350 bar (5000 psi) in l/min (USgpm)

Valve type	"0"	"1"	"2"	"3"	"6"	"7"	"8"	"33"
"22A"	—	—	15 (4)	—	—	—	—	—
"**A"	57 (15)	—	57 (15)	—	30 (8)	26 (7)	—	—
"**B"	76 (20)	19 (5)	57 (15)	76* (20)	26 (7)	57 (15)	38 (10)	57* (15)
"**C"	76 (20)	19 (5)	57 (15)	76* (20)	26 (7)	57 (15)	38 (10)	57* (15)
"**F"	76 (20)	19 (5)	57 (15)	76* (20)	26 (7)	57 (15)	—	57* (15)
"**N"	53 (14)	76 (20)	45 (12)	—	—	—	—	—

* 2 bar (30 psi) air pilot pressure required

Pressure drop curve reference chart

Spool type	P → A	B → T	P → B	A → T	P → T @ Center
"0B" "0C" "0F"	4	2	4	2	4
"1B" "1C" "1F"	5	3	5	3	6
"2B" "2C" "2F"	5	2	5	2	—
"3B" "3C" "3F"	6	3	6	1	—
"6B" "6C" "6F"	6	1	6	1	—
"7B" "7C" "7F"	4	3	4	3	—
"8B" "8C"	6	4	6	4	8
"33B" "33C" "33F"	5	2	5	2	**
"0A"	5	2	5	2	—
"2A"	6	5	6	5	—
"6A"	5	7	5	7	—
"7A"	6	7	6	7	—
"22A"	6	—	6	—	—
"0N"	3	7	3	7	—
"2N"	6	3	6	3	—
"6N"	7	1	7	1	—

** NOTE: Type "33" spool at center, will approximately pass 20 l/min. (5.3 USgpm) at 124 bar (1798 psi) inlet pressure.

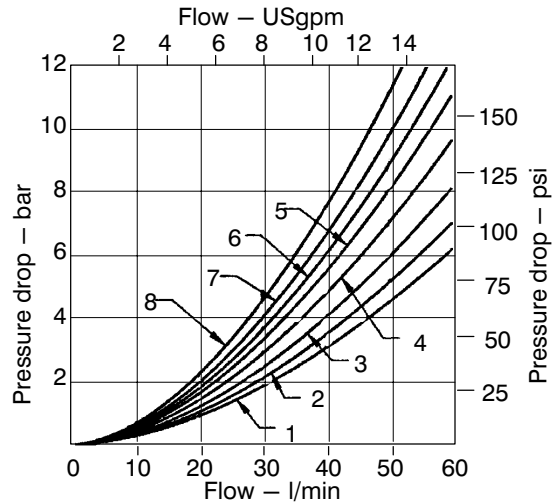

The pressure drop curves give approximate pressure drop ΔP when passing 36 cSt (100 SUS) fluid(s) having a specific gravity of .87.

For any other viscosity the pressure drop ΔP will change as follows:

Viscosity	14	32	43	54	65	76	86
cSt	14	32	43	54	65	76	86
(SUS)	(75)	(150)	(200)	(250)	(300)	(350)	(400)
% of ΔP (Approx.)	93	111	119	126	132	137	141

For any other specific gravity (G_1) * the pressure drop ΔP will be approximately: $\Delta P_1 = \Delta P (G_1 / G)$

* Specific gravity of fluid may be obtained from its producer.

DG18V-3 Installation Dimensions

DG18V-3-***-60** Air Operated

Millimeters (inches)

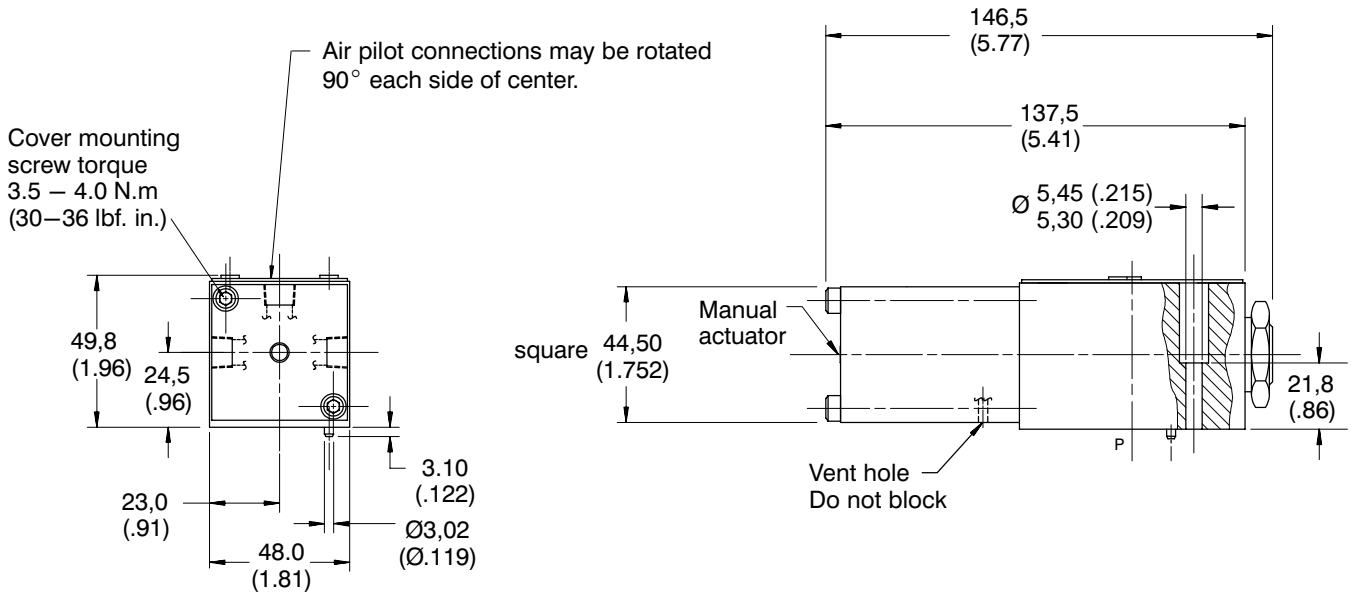
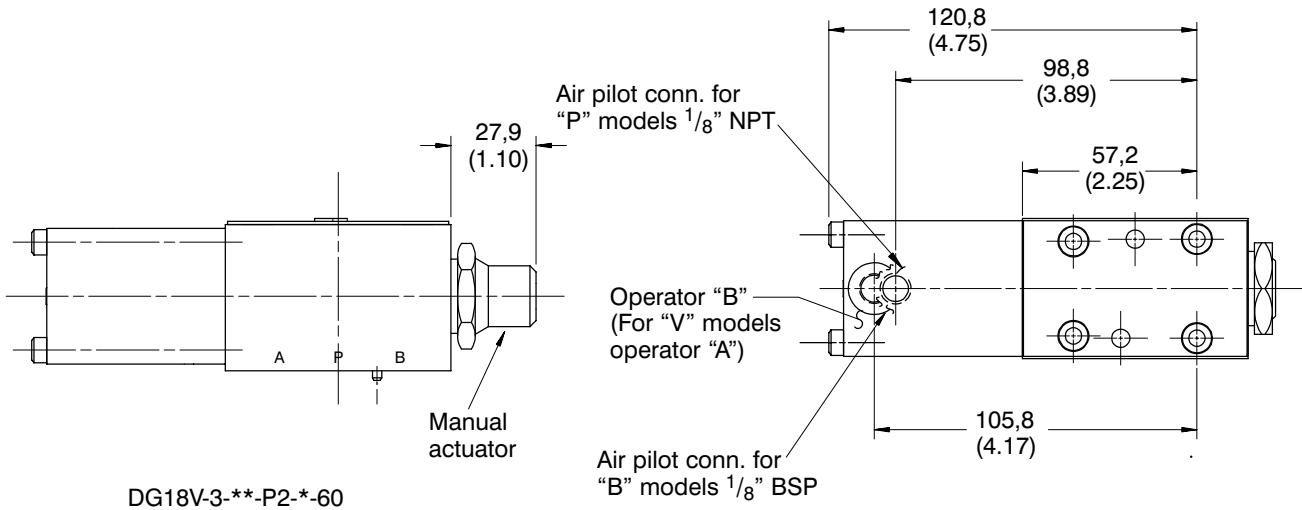

DG18V-3 Installation Dimensions

DG18V-3-***-60** Air Operated

Millimeters (inches)

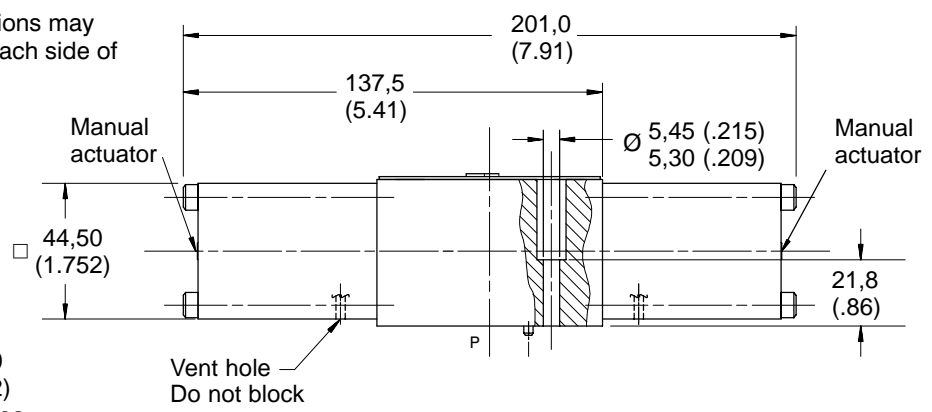
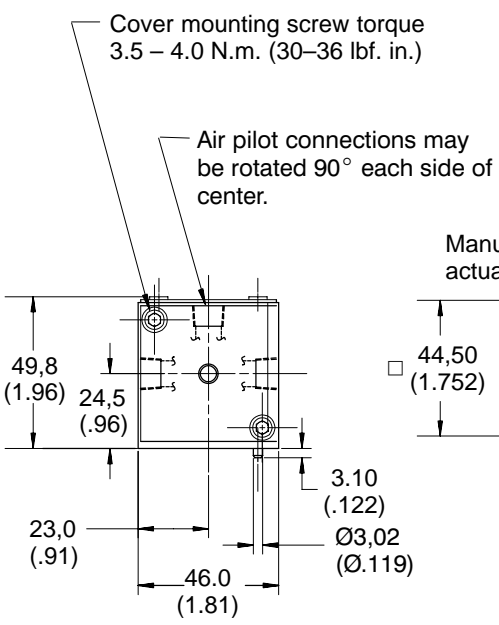
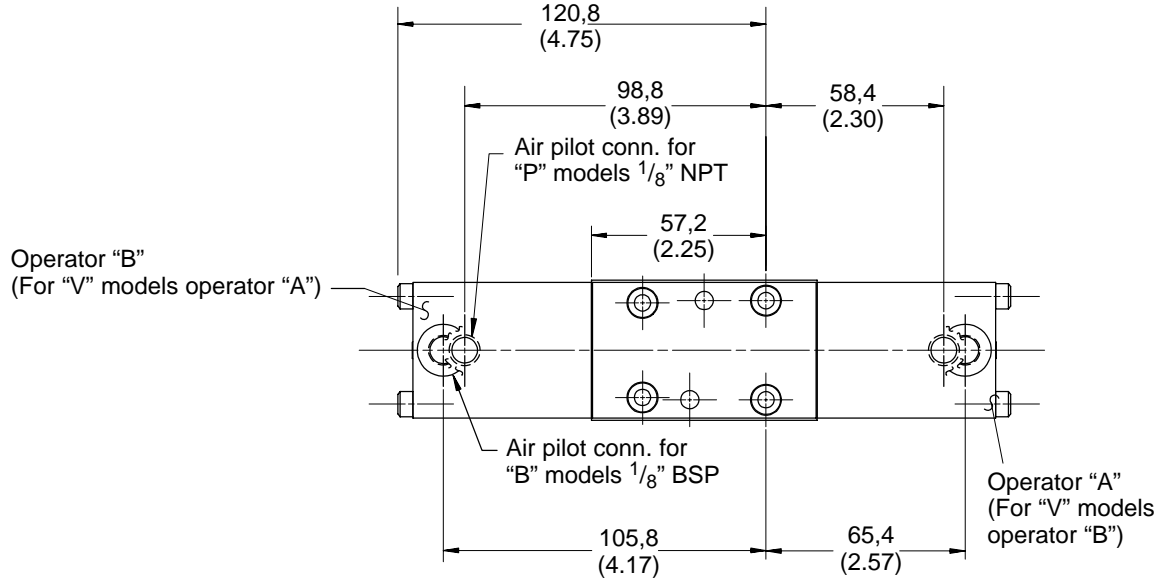

Mounting Interface

The minimum thread depth is 1.5 times bolt diameter. The recommended full thread depth is $2 \times D + 6\text{mm}$ to aid interchangeability of valves and to reduce the number of mounting bolt lengths. The recommended engagement of the mounting bolt thread for ferrous mounting is $1.25 \times D$.

Mounting surface must be flat within 0.013mm (.0005) and smooth within 1.1 micrometer (45 microinch). Mounting bolts when provided by customer should be grade 12.9 (SAE grade 7) or better.

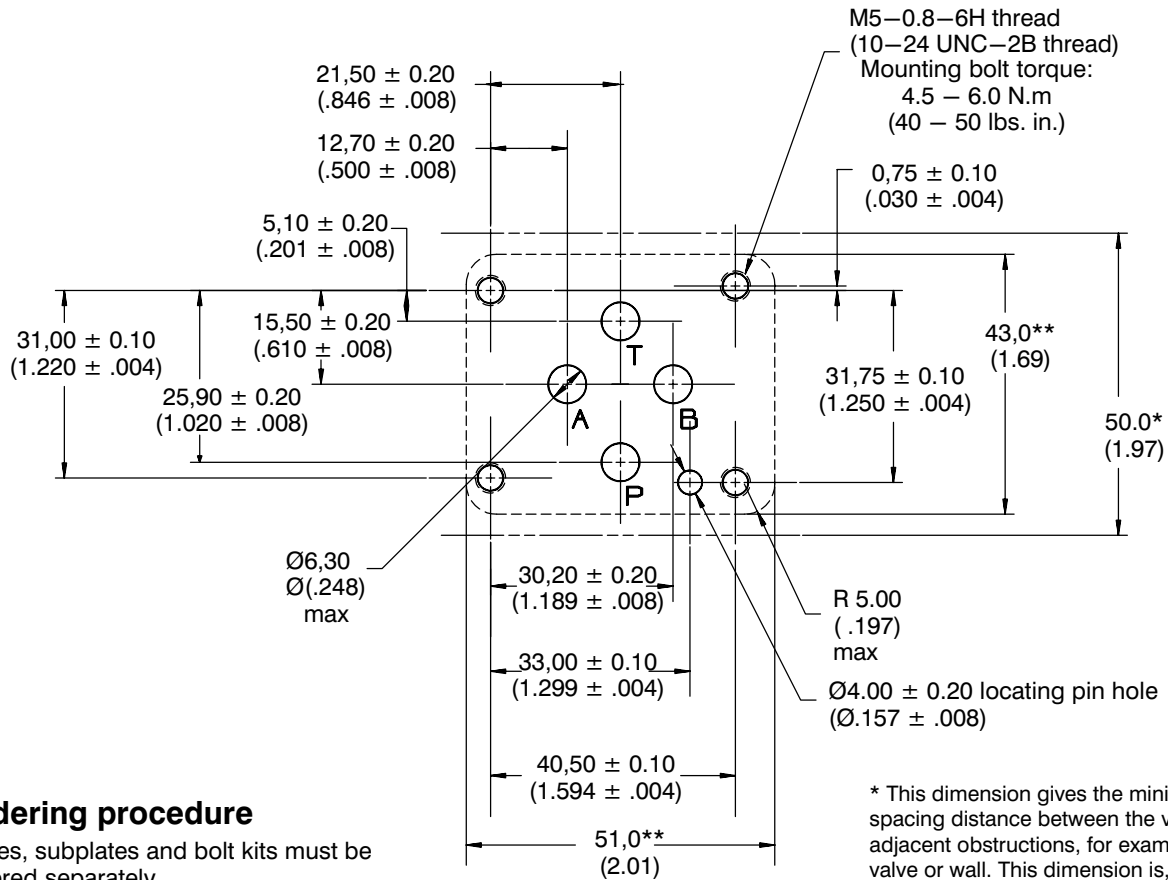

Ordering procedure

Valves, subplates and bolt kits must be ordered separately.

Example:

- (1) DG3/17/18/20V-3-2C-60 Valve
- (1) DGVM-3-10-S Subplate
- (1) BK590716 Mounting bolt kit (inch)
- (1) BK616452M Mounting bolt kit (metric)

* This dimension gives the minimum spacing distance between the valve and adjacent obstructions, for example, another valve or wall. This dimension is, therefore, the minimum distance from centerline to centerline of two similar mounting surfaces placed on a manifold block. The mounting holes are at equal distance to this dimension.

**The dimensions specifying the area within the dotted lines are the minimum dimensions for the mounting surface. The corners of the rectangle may be radiused as shown.

Application Data

Fluid Cleanliness

Proper fluid condition is essential for long and satisfactory life of hydraulic components and systems. Hydraulic fluid must have the correct balance of cleanliness, materials, and additives for protection against wear of components, elevated viscosity, and inclusion of air.

Essential information on the correct methods for treating hydraulic fluid is included in Vickers publication 561 "Vickers Guide to Systemic Contamination Control" available from your local Vickers distributor or by

contacting Vickers, Incorporated. Recommendations on filtration and the selection of products to control fluid condition are included in 561.

Recommended cleanliness levels, using petroleum oil under common conditions, are based on the highest fluid pressure levels in the system and are coded in the chart below. Fluids other than petroleum, severe service cycles, or temperature extremes are cause for adjustment of these cleanliness codes. See Vickers publication 561 for exact details.

Vickers products, as any components, will operate with apparent satisfaction in fluids with higher cleanliness codes than those described. Other manufacturers will often recommend levels above those specified. Experience has shown, however, that life of any hydraulic component is shortened in fluids with higher cleanliness codes than those listed below. These codes have been proven to provide a long, trouble-free service life for the products shown, regardless of the manufacturer.

Product	System Pressure Level bar (psi)		
	<70 (<1000)	70-207 (1000-3000)	207+ (3000+)
Vane Pumps – Fixed	20/18/15	19/17/14	18/16/13
Vane Pumps – Variable	18/16/14	17/15/13	
Piston Pumps – Fixed	19/17/15	18/16/14	17/15/13
Piston Pumps – Variable	18/16/14	17/15/13	16/14/12
Directional Valves	20/18/15	20/18/15	19/17/14
Pressure/Flow Control Valves	19/17/14	19/17/14	19/17/14
CMX Valves	18/16/14	18/16/14	17/15/13
Servo Valves	16/14/11	16/14/11	15/13/10
Proportional Valves	17/15/12	17/15/12	15/13/11
Cylinders	20/18/15	20/18/15	20/18/15
Vane Motors	20/18/15	19/17/14	18/16/13
Axial Piston Motors	19/17/14	18/16/13	17/15/12
Radial Piston Motors	20/18/14	19/17/13	18/16/13

Fluids and Seals

Flouorocarbon seals are standard and are suitable for use with phosphate ester type fluids or their blends, water glycol, water-in-oil emulsion fluids and petroleum oil. Refer to 694 for hydraulic fluid and temperature recommendations.